

Read the instruction before operating your shade

**Installation & Maintenance Instructions
Honeycomb Shade
45mm & 62mm SmartFit™ / SmartFit™
Day & Night
with Alum Preinstalled Top Rail**

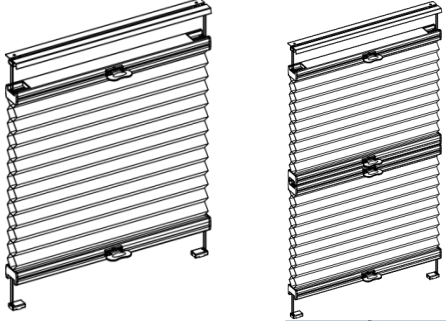

Getting Started



Remove the shade from the package. Save the packaging until the shade is installed and working to your satisfaction.

Recommended Tools

- Power drill and drill bit
- Measuring tape
- Screwdriver
- Level
- Pencil



You will need to use the following fasteners for your particular mounting surfaces:

Surface	Fastener
Wood	Screws (Provided) 
Drywall/Plaster	Wall Anchors, Expansion Bolts (Not Provided) 
Metal	Sheet Metal Screws (Not Provided) 

Check Hardware

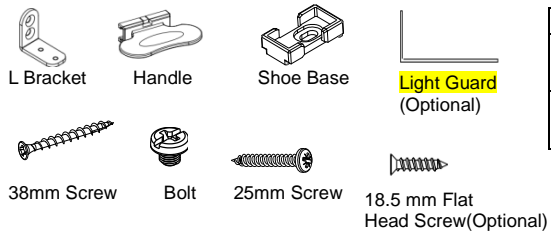

Step 1. Prepare the Shade for Installation

Carefully unwind the cord in the opposite tied direction. Remove the cardboard and PE bag. The rail with magnet installed on the ends is the rail on the top.

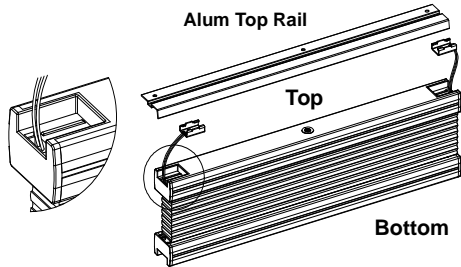

Step 2. Alum Top Rail, Shoe Base and Bracket Installation

Inside Mount – Alum Top Rail Installation

The minimum distance from the left/right side wall to the end of Alum Top Rail is 3mm.

Allocate a minimum distance (L1) from wall to the front of Alum Top Rail.

Secure the Alum Top Rail with 25mm screws through the screw holes pre-drilled on the Top Rail.

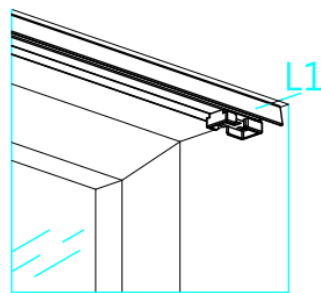
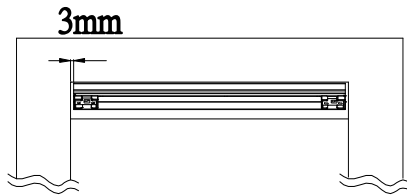

For 45mm

Distance	Application Condition
L1 ≥ 10mm	.With light guard front and back
L1 ≥ 7mm	.Without light guard, & with light guard at back

For 62mm

Distance	Application Condition
L1 ≥ 6 mm	.With light guard front and back
L1 ≥ 2 mm	.Without light guard, & with light guard at back

Inside Mount – Shoe Base Installation

Match the outer edge of the Shoe Base to the marked position. The minimum distance from the bottom left/right side wall to the Base side is 3mm.

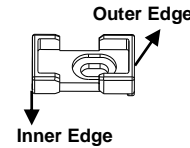

Allocate a minimum distance (L2) from wall to the front of Shoe Base.

Install the Shoe Base with one 25mm screw.

For 45mm

Distance	Application Condition
L2 ≥ 21mm	.With light guard front and back
L2 ≥ 17mm	.Without light guard, & with light guard at back

For 62mm

Distance	Application Condition
L2 ≥ 24 mm	.With light guard front and back
L2 ≥ 20 mm	.Without light guard, & with light guard at back

*The minimum distance from wall to the front of Shoe Base (L2) subtracts minimum distance from wall to the front of Alum Top Rail (L1) must equal 10mm for 45mm cell size, and 19mm for 62mm cell size shade.

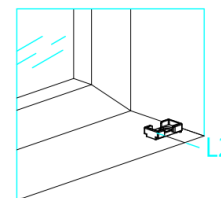

Inside Mount – L bracket Installation (side mounted) for windows with marble sill (Optional, not available for 62mm cell size)

Allocate a distance of 16mm (L4) from bottom corner window frame and use 2pcs 38mm screws to secure the L bracket.

Use 1pc 3.6mm bolt to attach base to the L bracket (through inner screw hole).

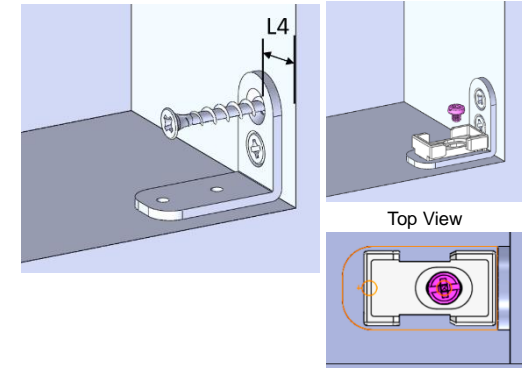

Outside Mount –L Bracket Installation (Not available for 62mm cell size)

For outside mount, the Shoe Base, L bracket, and magnet catch (if needed) has been pre-installed on the Alum Top Rail.

Place the Alum Top Rail at the desired position, make sure to keep minimum distance (L3) between the edge of L bracket and the top/bottom window frame ≥ 9mm.

Meanwhile, it is also essential to assure the distance between the top / bottom of the shade to the edge of bottom / top of the L bracket equals shade drop subtracts 23mm.

Keep L bracket parallel with the window frame and secure the L Bracket with 2pcs 38mm screws to the wall.

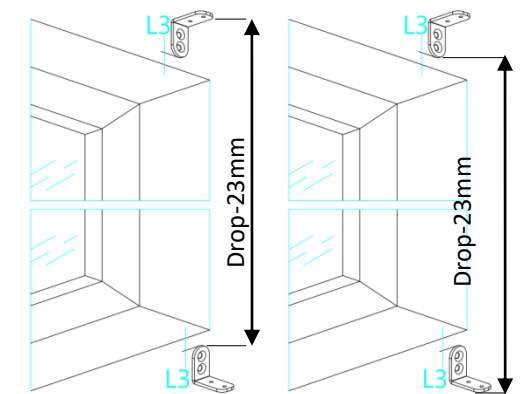

Top of the shade to the edge of bottom of the L bracket equals shade drop - 23mm

Bottom of the shade to the edge of top of the L bracket equals shade drop - 23mm

Recommendation: avoid the gypsum board surface.

Step 3. Install the Shade

Install the Shoe Slider onto Shoe Base by pushing down the Slider from top of the notch then slide to the side to match the Base. Make sure that cords are nice, tight and not tangled.

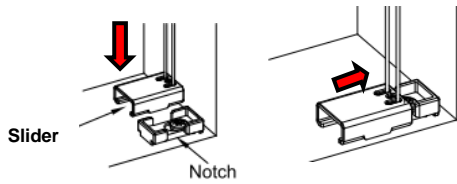
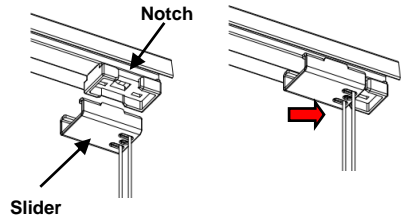

For SmartFit™

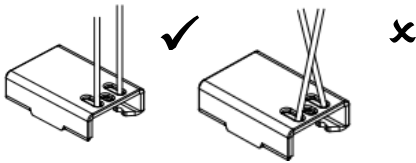

For SmartFit™ Day & Night

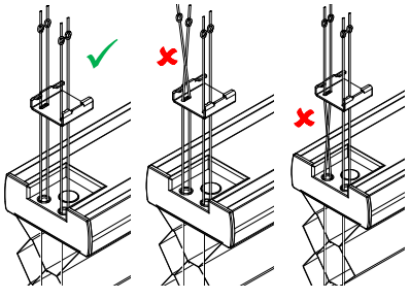

For child safety, please check and ensure that there are no loose cords after the shade is completely installed. If the shade is too loose, please retie a new knot for it.

Remove bottom shoe slider, untie the knot and make a new knot for adjustment. Please do not tie the cord too tight as it will cause too much friction.

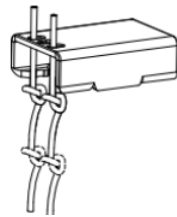

Notes: When installing the Shoe slider, it is suggested to secure the bottom shoe slider first, and then unfasten the top cord to secure the top shoe slider. Please do NOT untie the top cord until the bottom shoe slider is secured.

Step 4. Handle Installation

Attach the handle to the handle support pre-attached on the rail then slide against the handle support to the left until the handle can't move anymore.

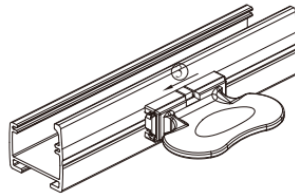
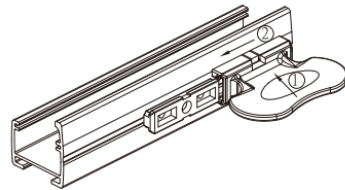

Step 5. Operate your Shade

Do not grasp the rail unevenly. Always lower or raise the shade in the middle or use both hands with even pressure to two handles of the rail.

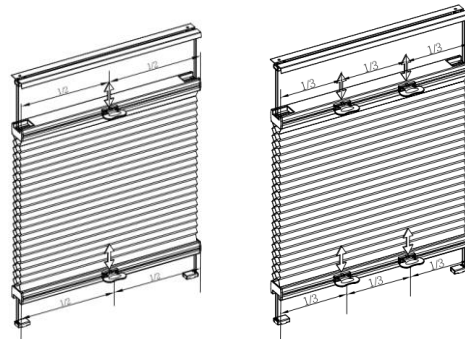

Step 6. Adjust the Shade

After the shade is completely installed, use the handle to raise the shade up to the top and adjust the shade to level. Then you may operate the shade to any desired position.

Step 7. Remove the Shade

Operate the shade to the middle from top and bottom. Remove the Shoe Slider from the Shoe Base.

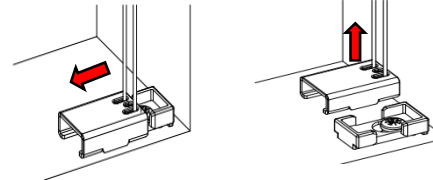

Step 8: Install Light Guard (Optional for IM)

Please install the light guard after installation of the shade is completed.

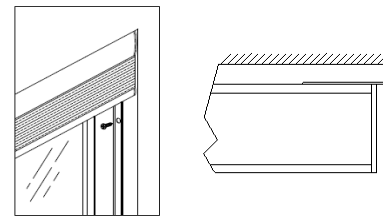

With light guard at back

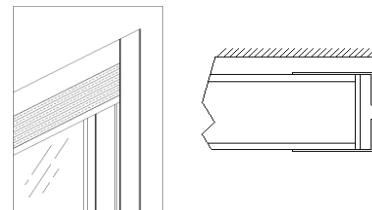

With light guard at front and back

a. The light guard is to be placed at back or front of the shade at left & right side.

Place the light guard vertically towards the bottom window frame. To avoid scraping, leave a 2mm gap between fabric stack and light guard. And then mark out the location with a pencil.

Remove the double sided tapes on the narrow side of the light guard and carefully paste the light guard to the window frame in position.

b. For better fixing the light guard to the window, use 18.5mm flat head screw to secure the light guard through the pre-drilled hole.



c. When light guard length (L) > 2438mm, light guard will be sliced into 2 pieces. There are two conditions as listed below.

Light guard length (L)	Short piece Light Guard Length	Long piece Light Guard Length
2438mm < L ≤ 3048mm	610mm	L-610mm
L > 3048mm	L-2438mm	2438mm

When light guard sliced into 2pcs, firstly paste the longer piece of light guard vertically towards the bottom window frame, and paste the shorter piece of light guard above the longer one, the edges must be carefully aligned.

To avoid the edges from scraping the fabric, use the protective sticker to completely cover the joint of the two pieces of light guard on both front and back sides of light guard as diagram on the right.

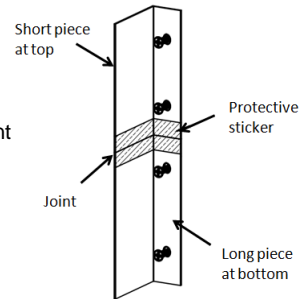

Cleaning Instructions

Routine cleaning will help maintain the beauty of your shade. The shade can be cleaned by using a soft brush, vacuumed with a low suction hand-held vacuum, cleaned ultrasonically (specify that a mild solution must be used and that the head rail should never be immersed in liquid), or dampen a clean cloth with a warm water and mild detergent solution to dab the spot until it's gone (do not rub!).